

# UITBREIDING IBKC WIJZER

## BOP Architecten

d.d. 28-02-2023

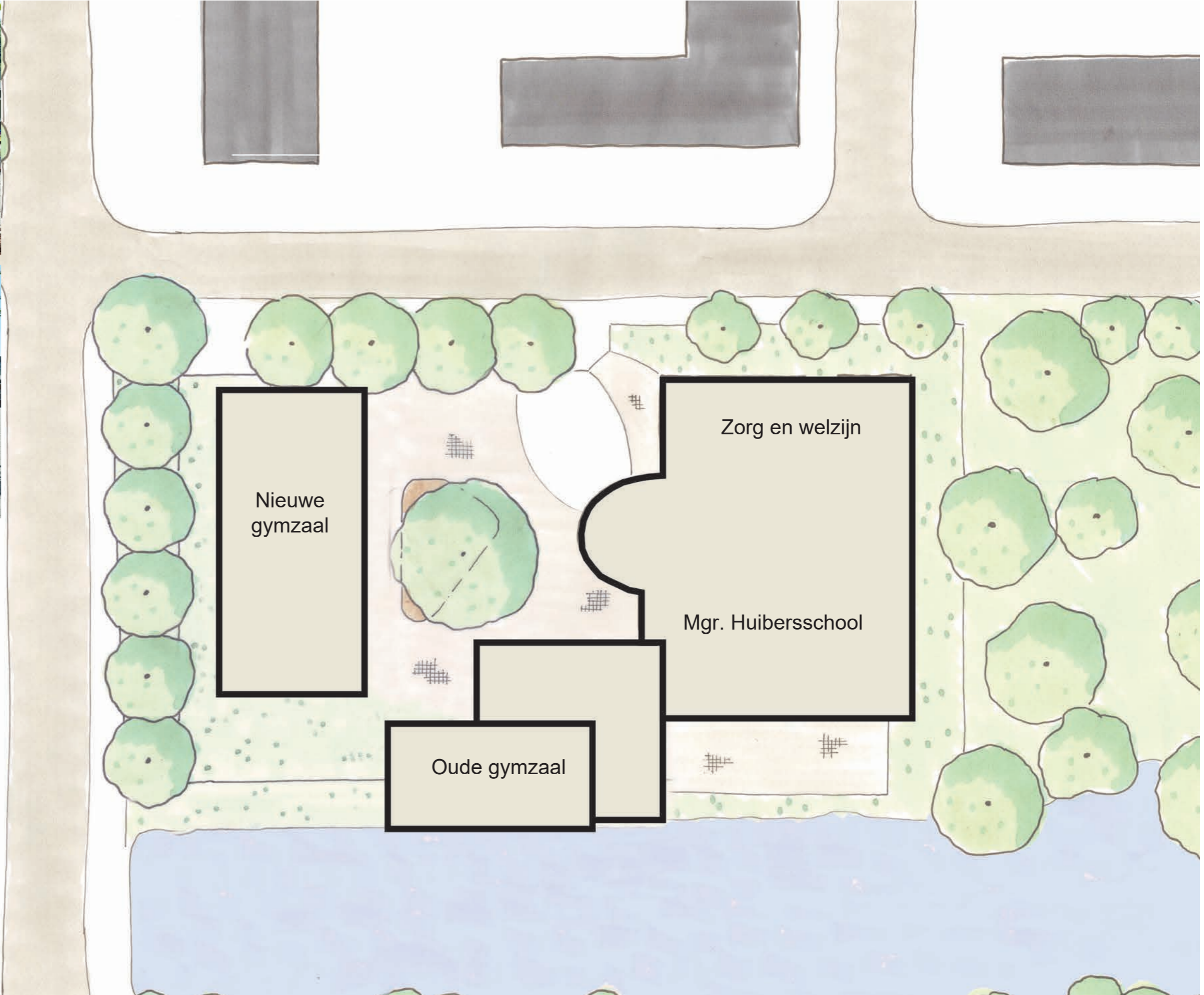
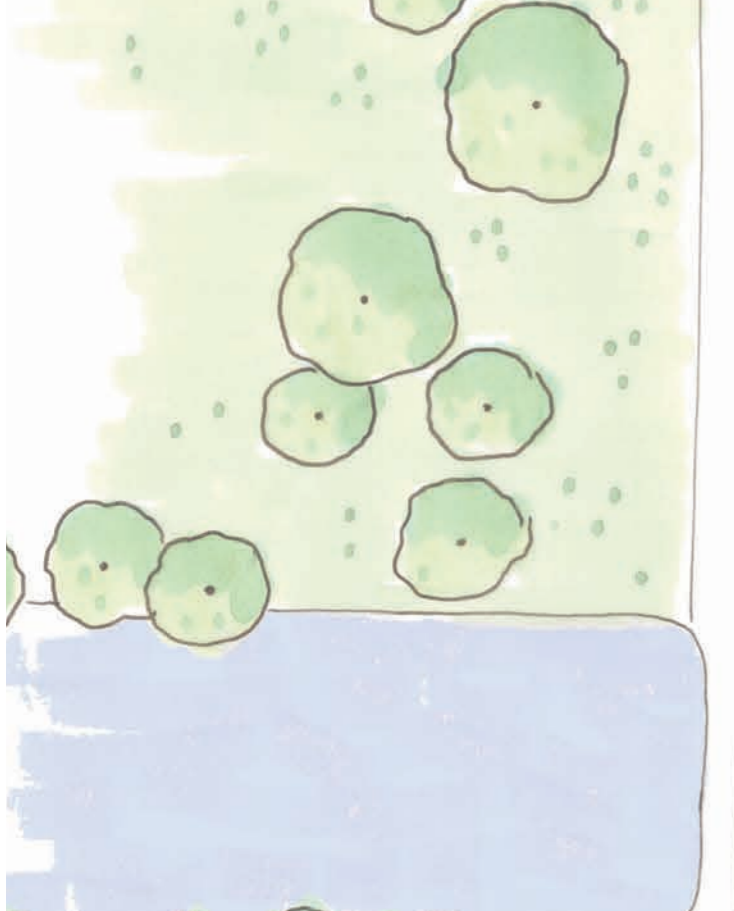

# AMBITIES NIEUWE STEDENBOUWKUNDIGE TOESTAND

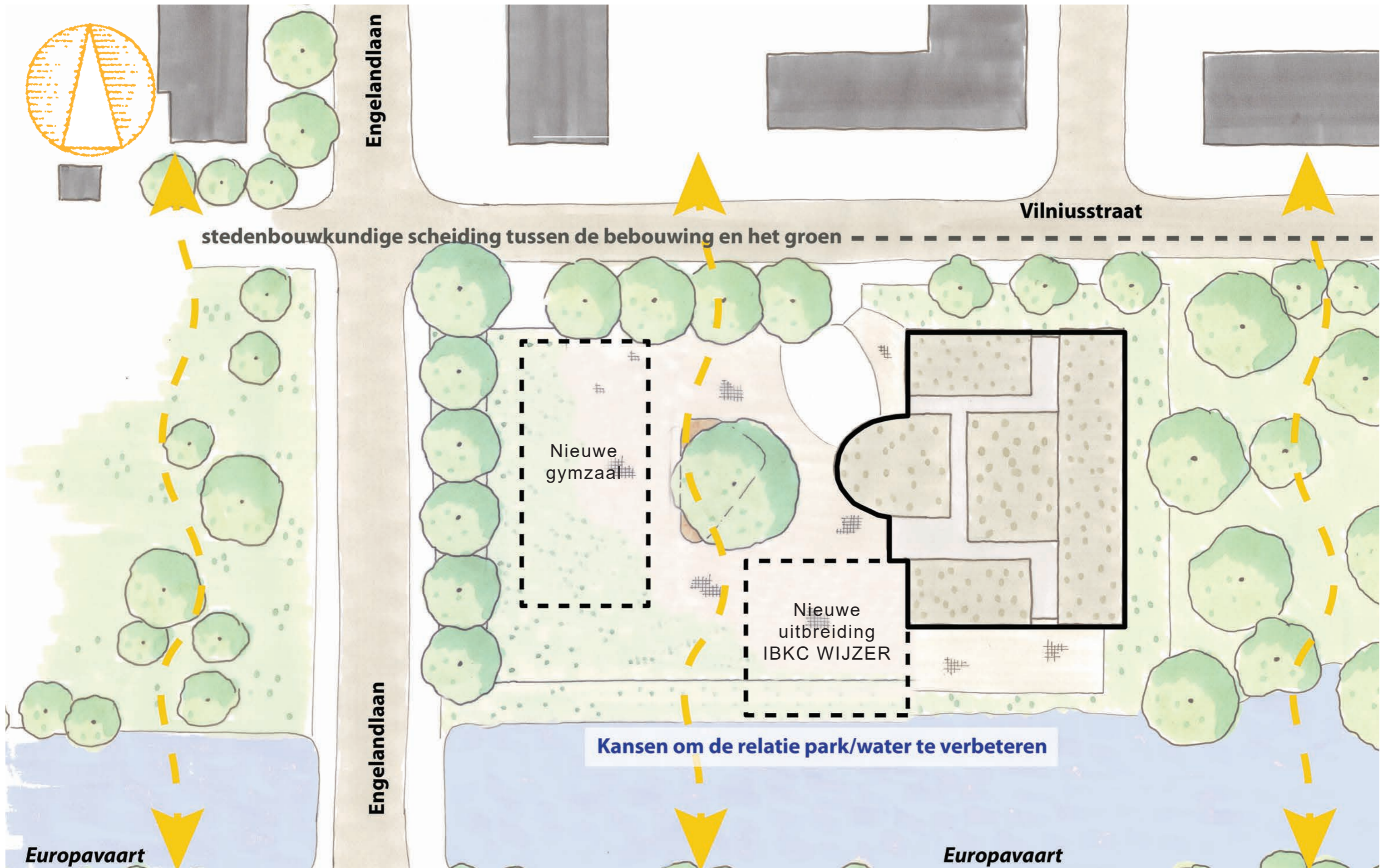

Europavaart

Europavaart

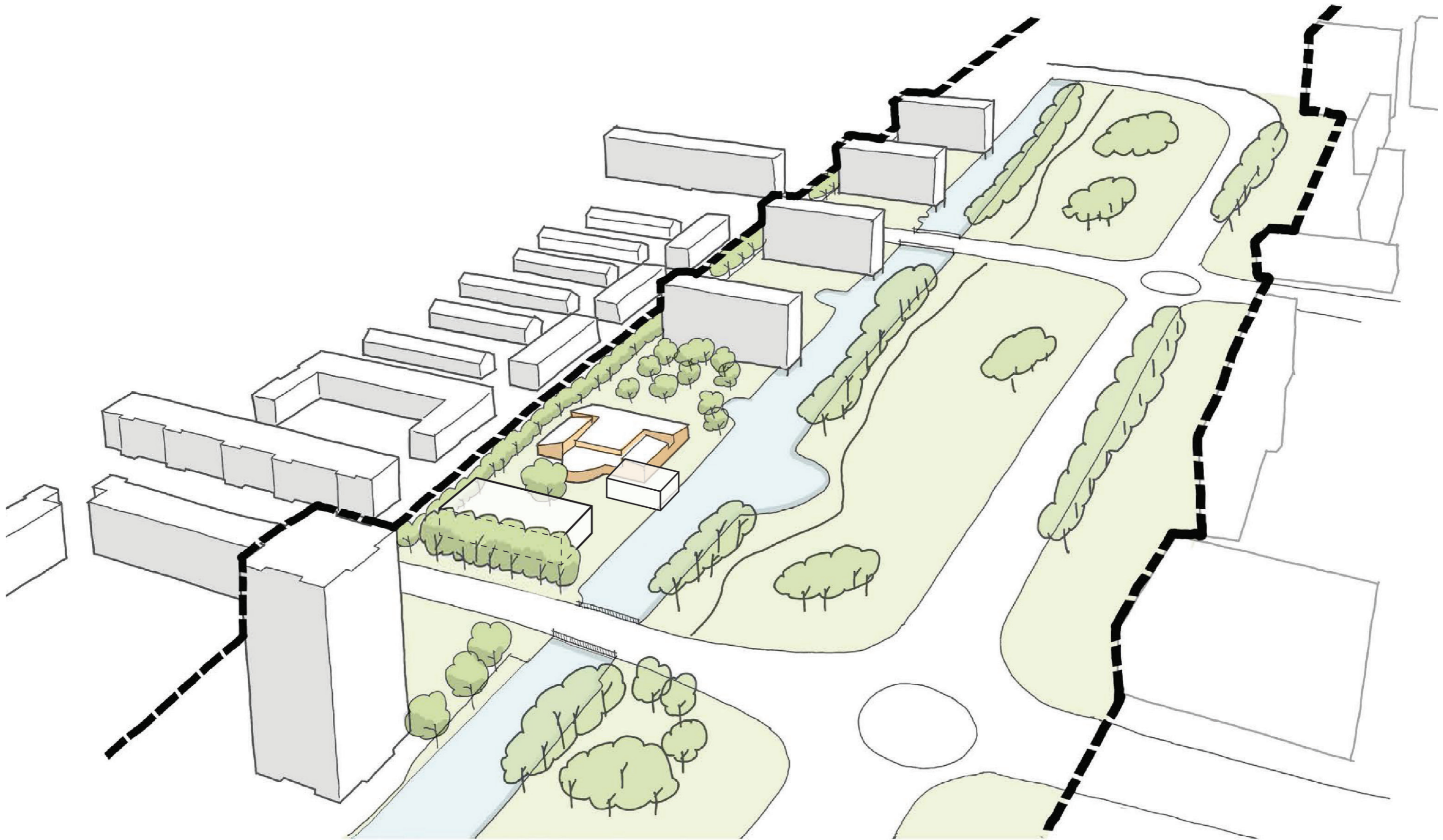



**plein 1:** geborgenheid (grotendeels omsloten)

**plein 2:** op het water gericht, goed zichtbaar

**plein 3:** privé, moestuintjes, vanuit de school bereikbaar

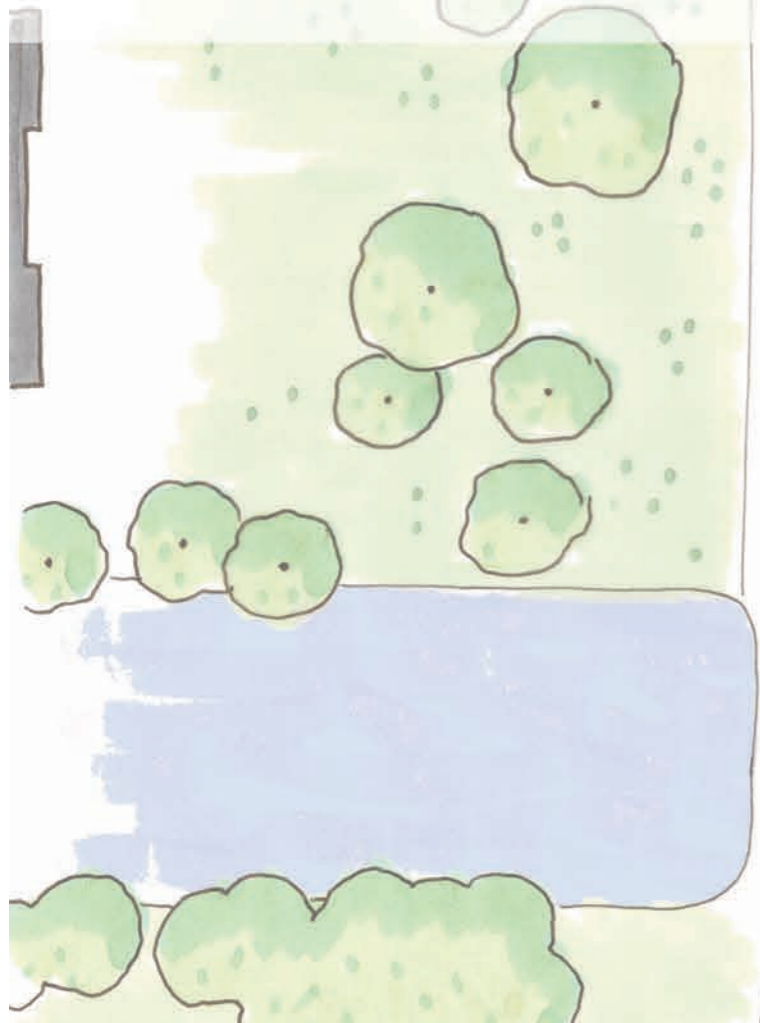

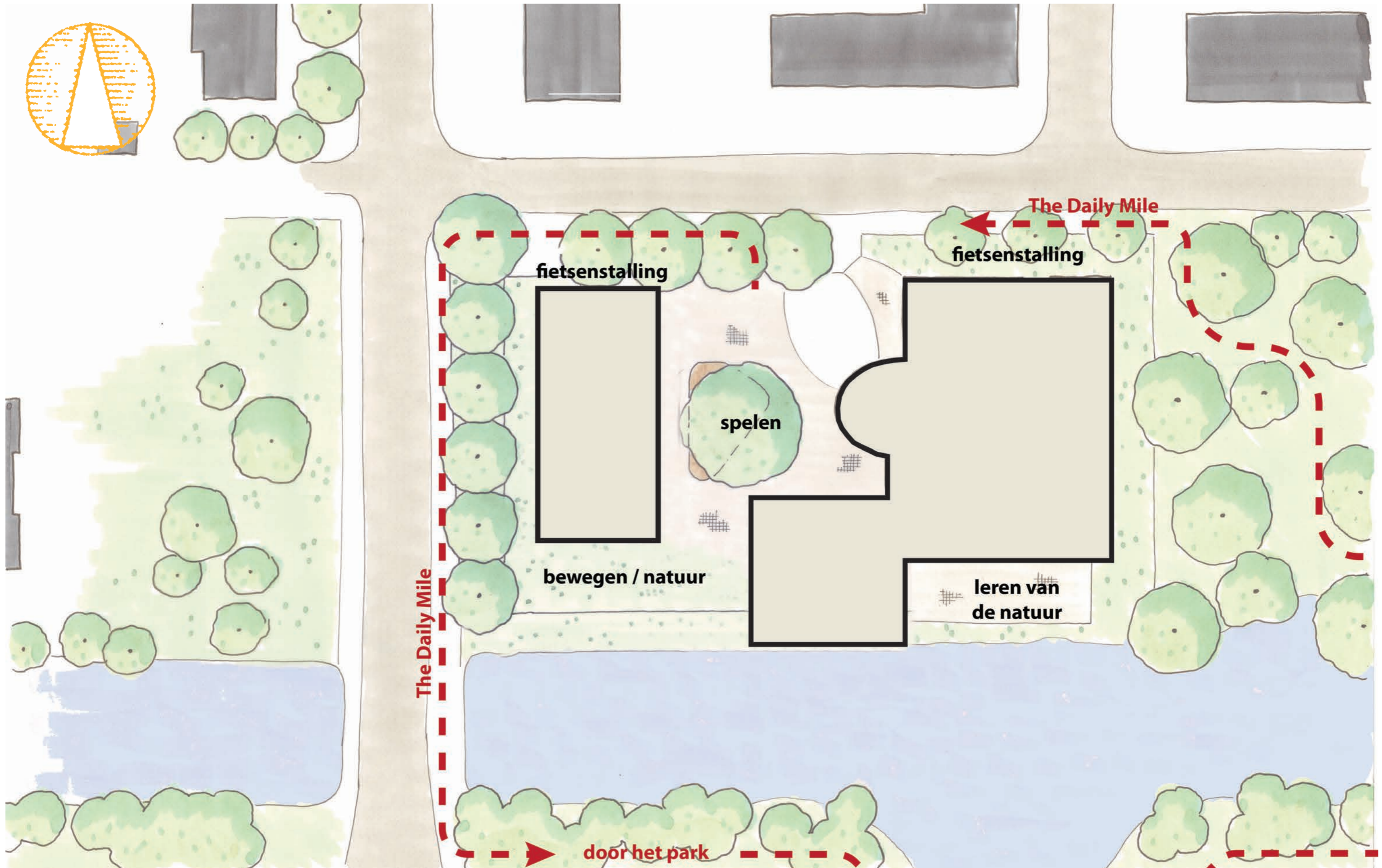



## BESTAANDE TOESTAND

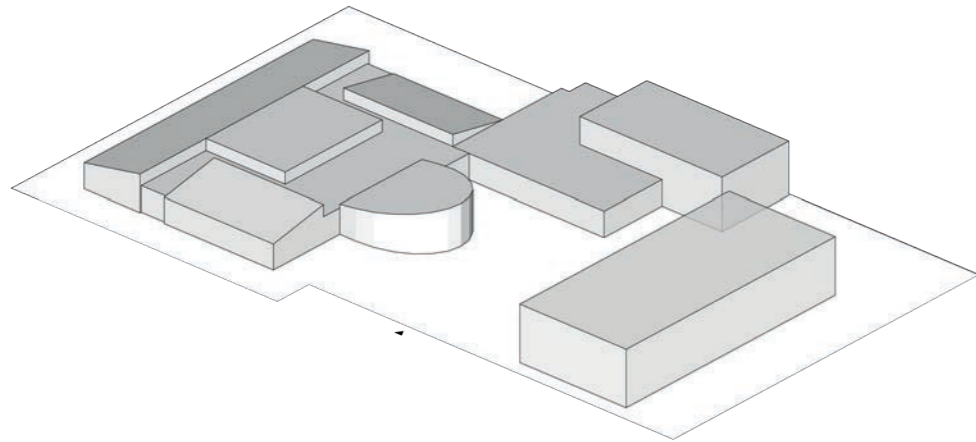

## VOLUME PVE

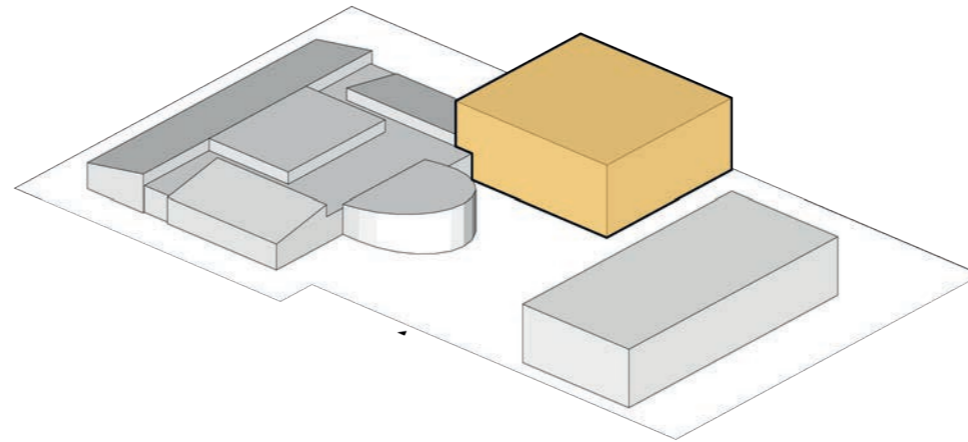

## AANSLUITEN OP BESTAAND

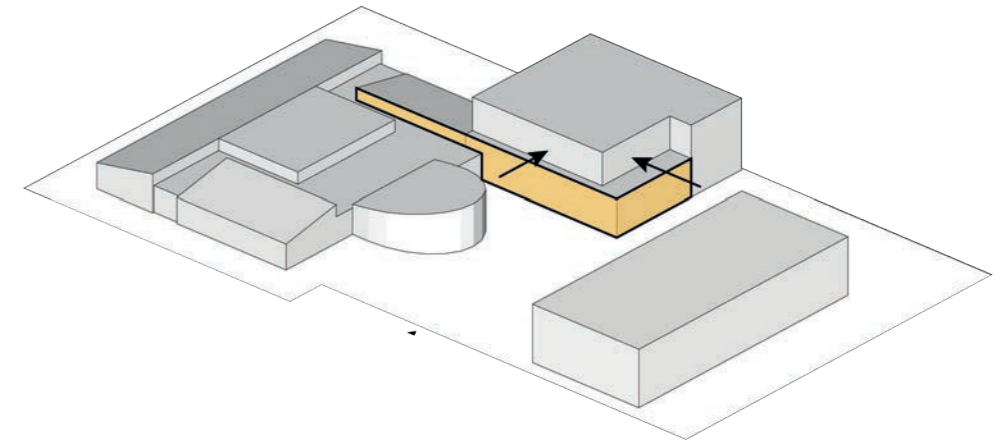

## FRAGMENTATIE VAN VOLUME

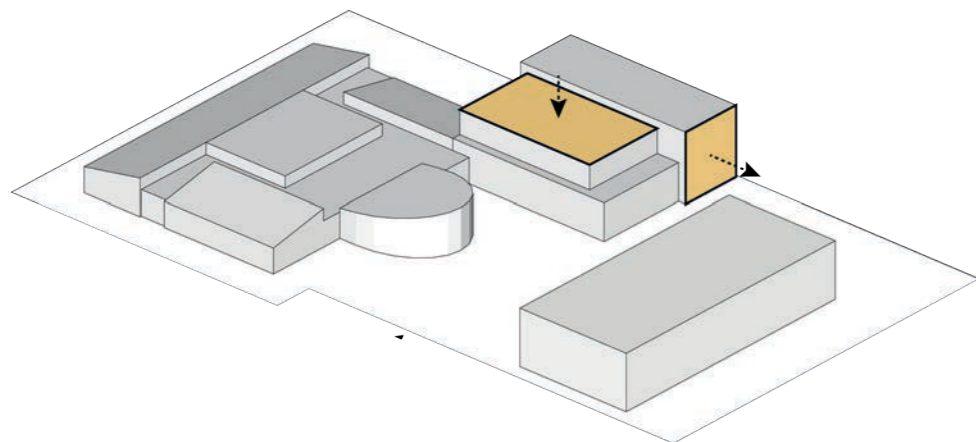

## TOEVOEGEN ACCENT

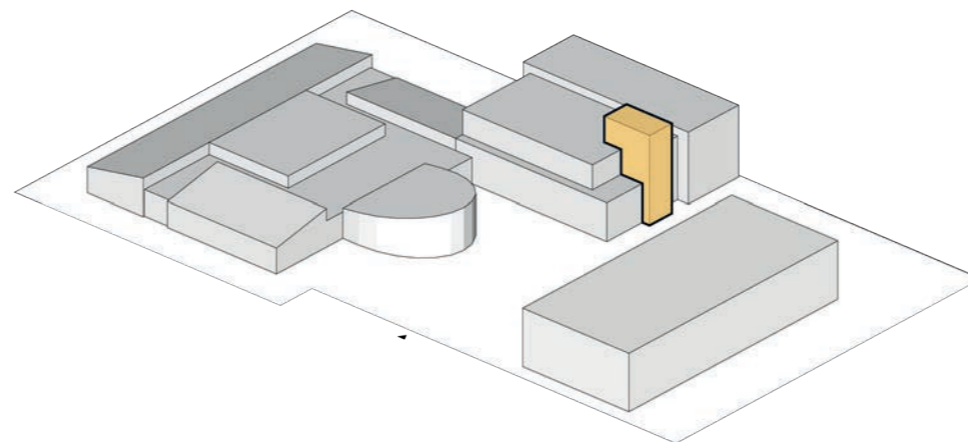

## VERSCHIL IN MATERIALISATIE

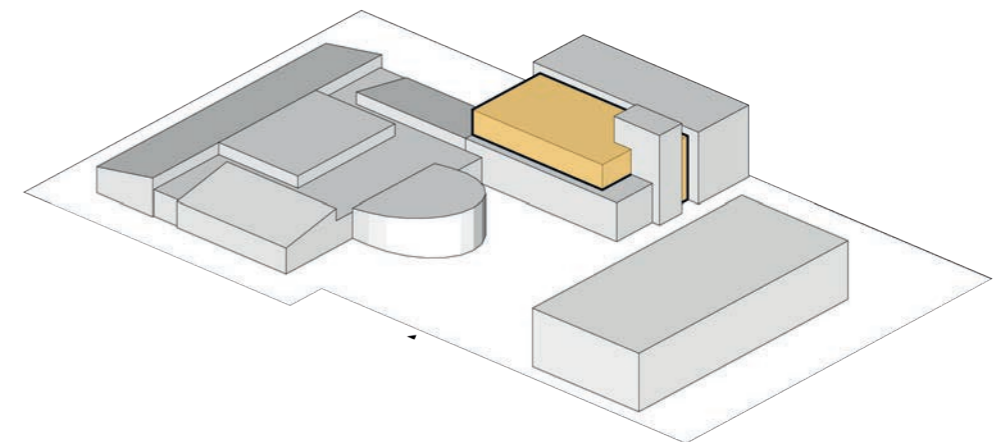



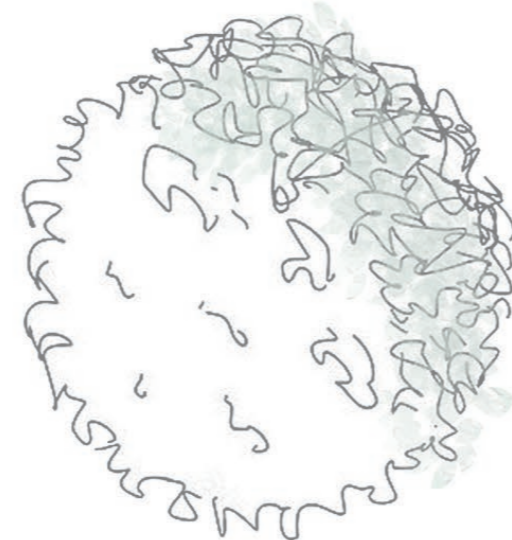
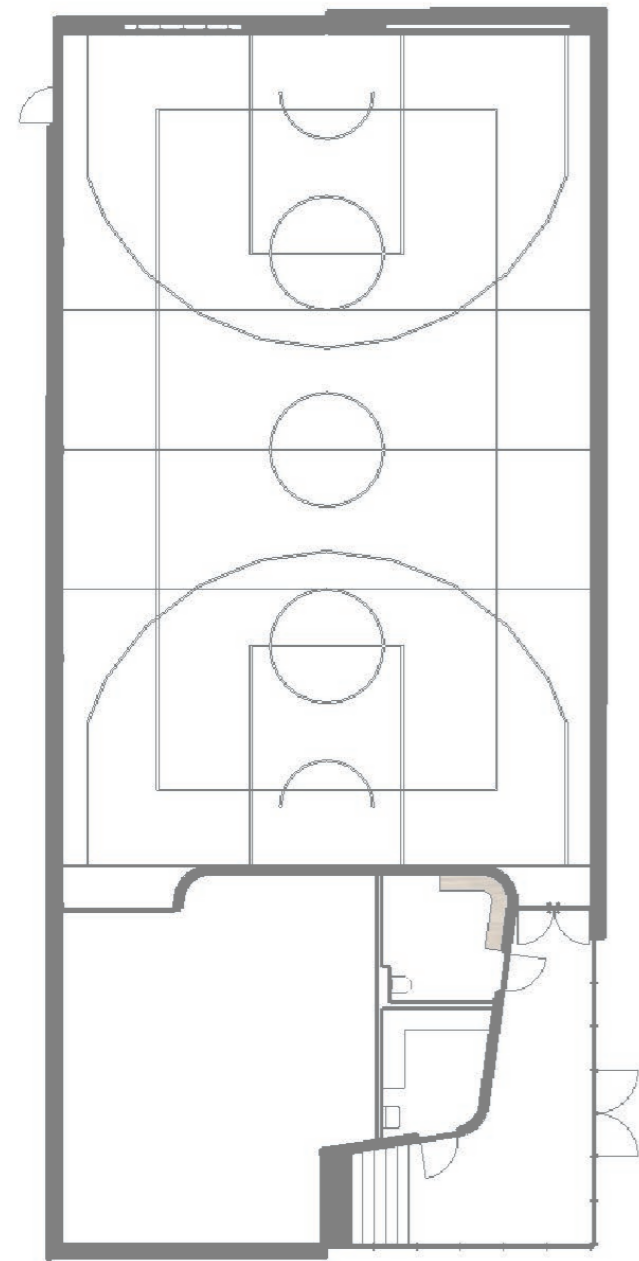

**HOOFDENTREE**

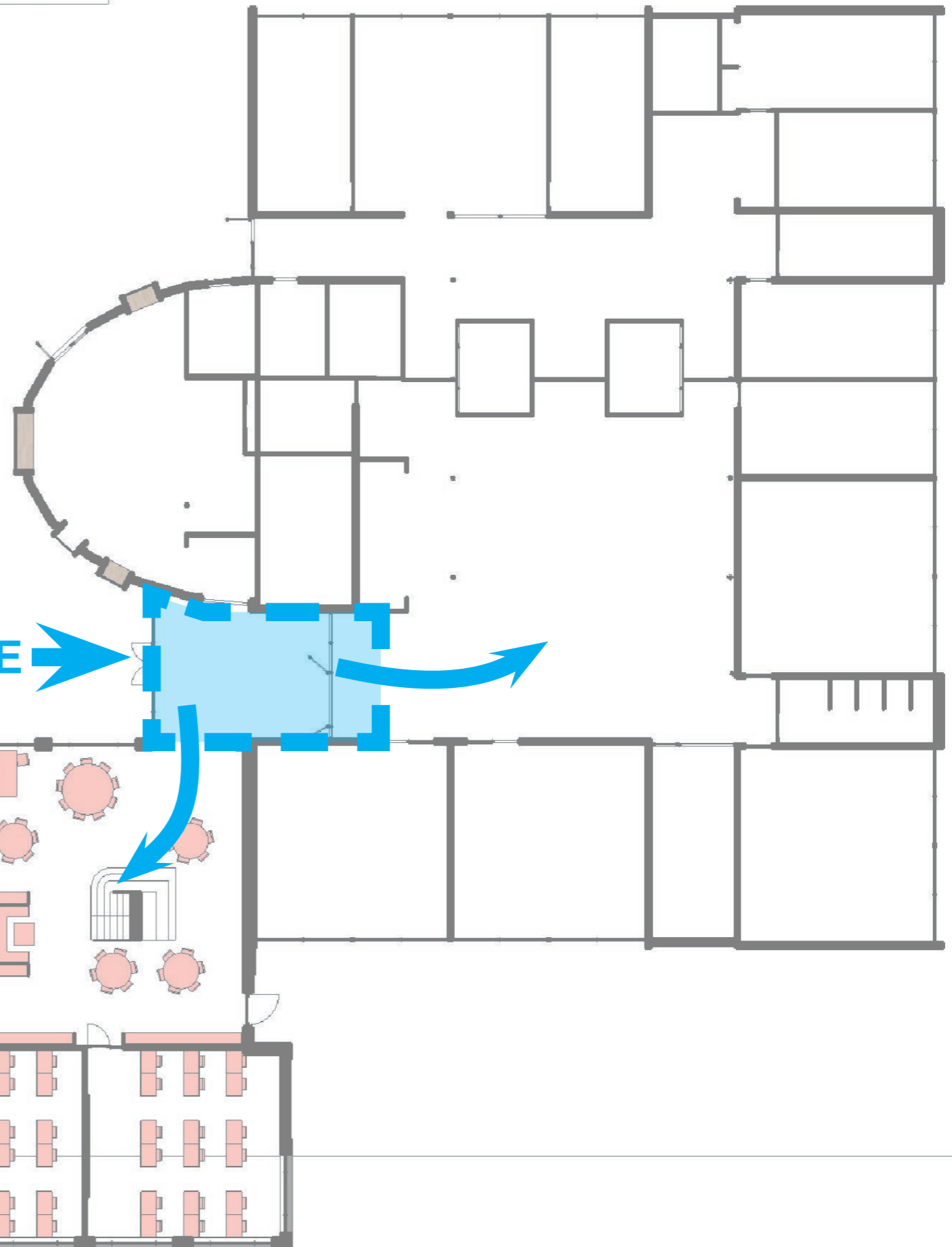

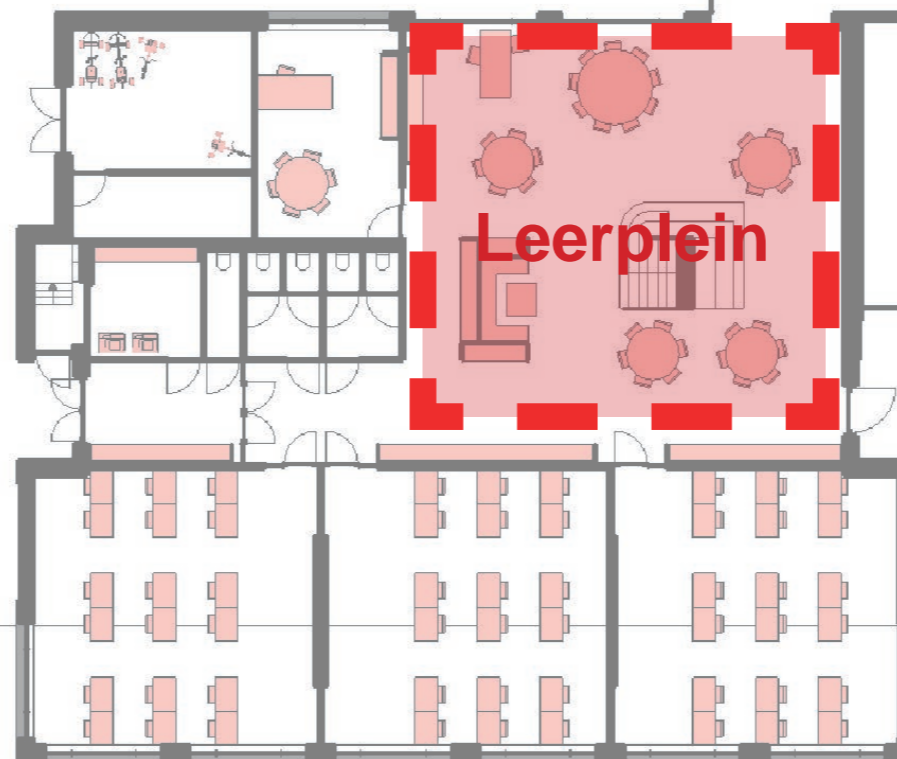
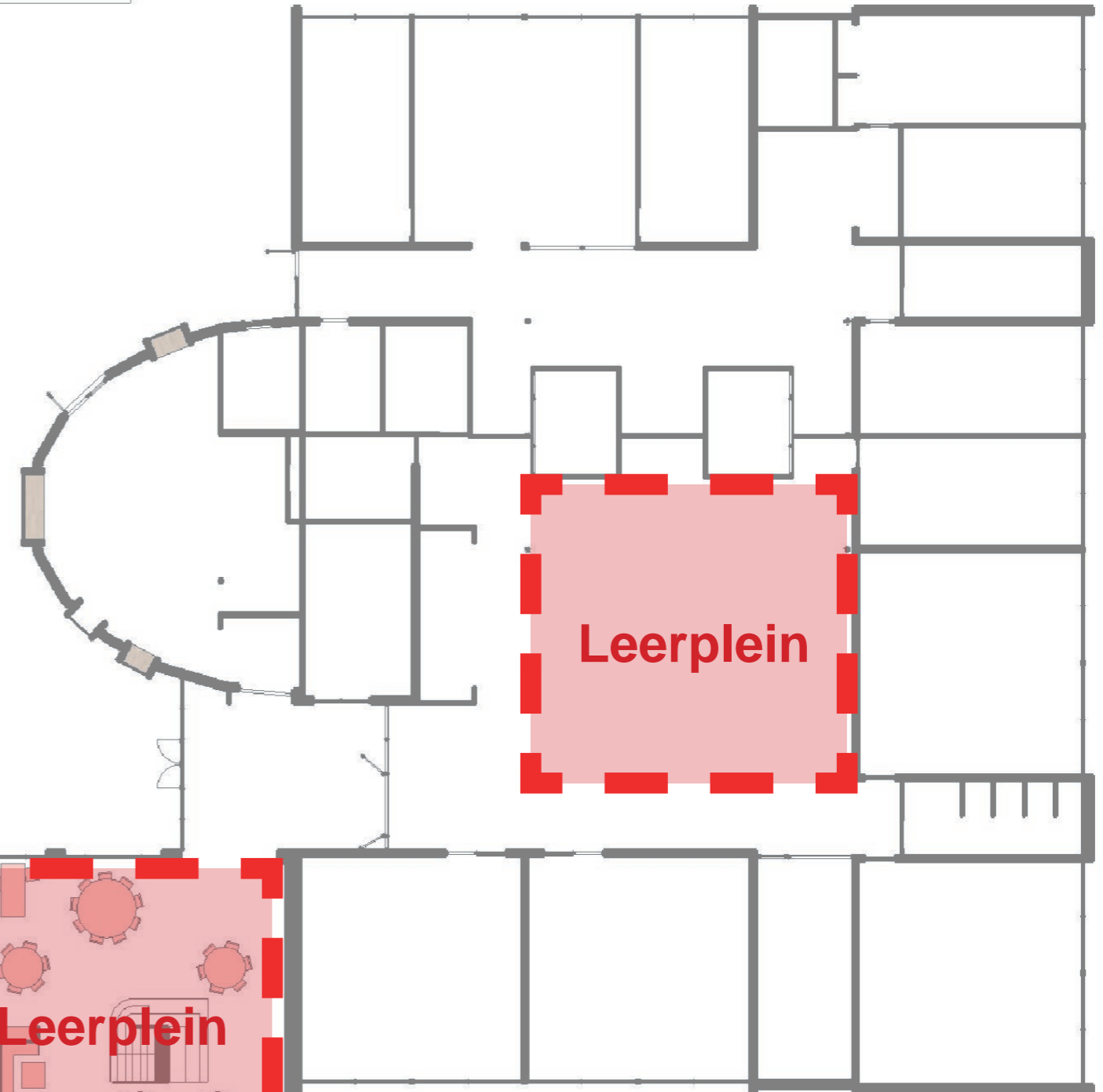
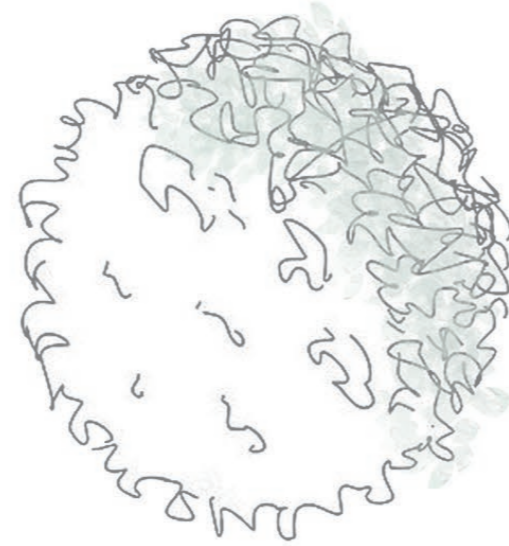
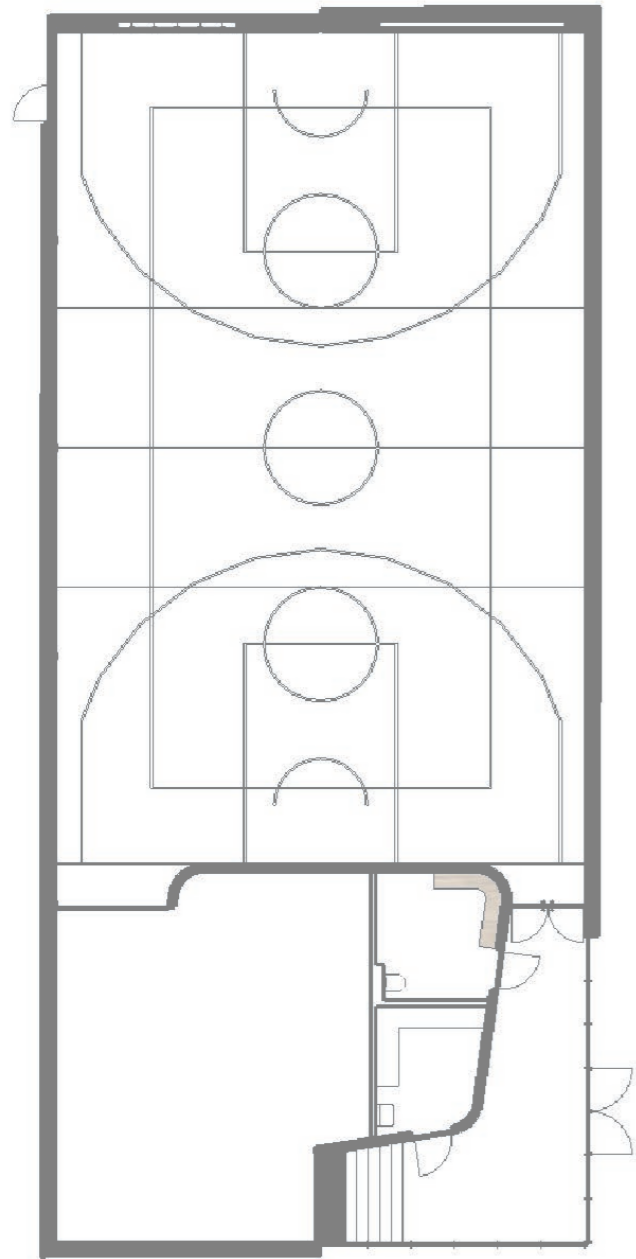

# BEGANE GROND (lokalen)

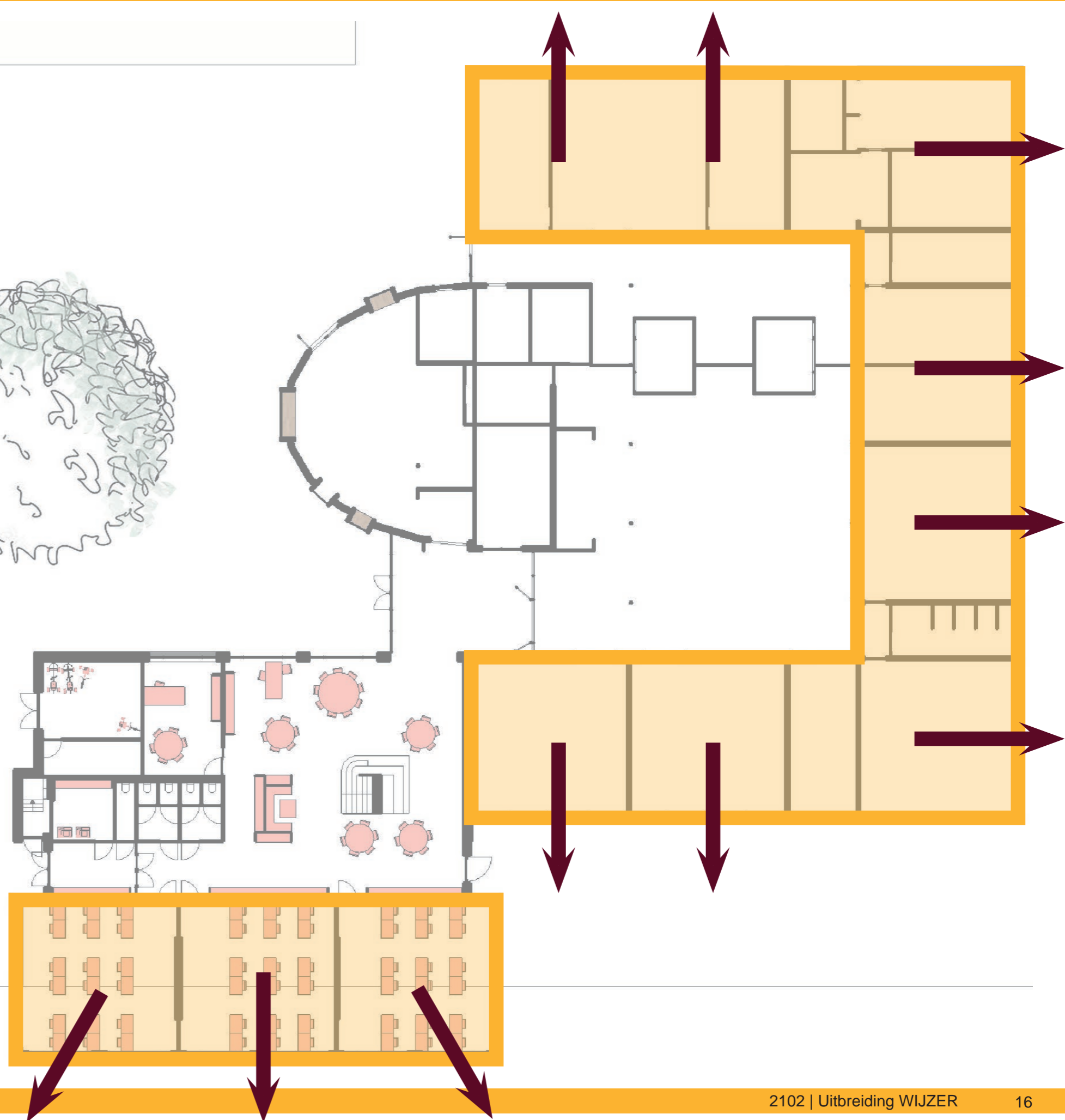
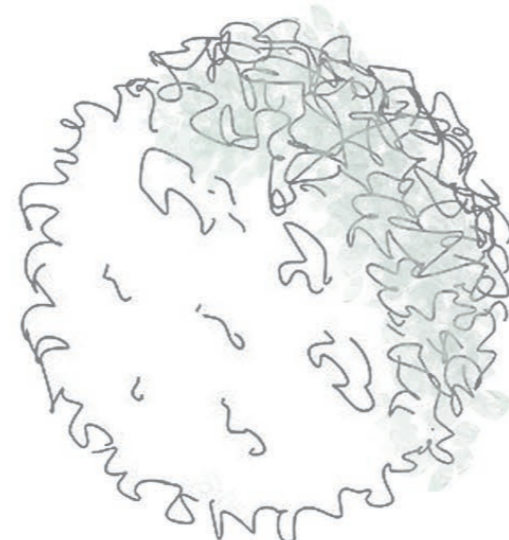
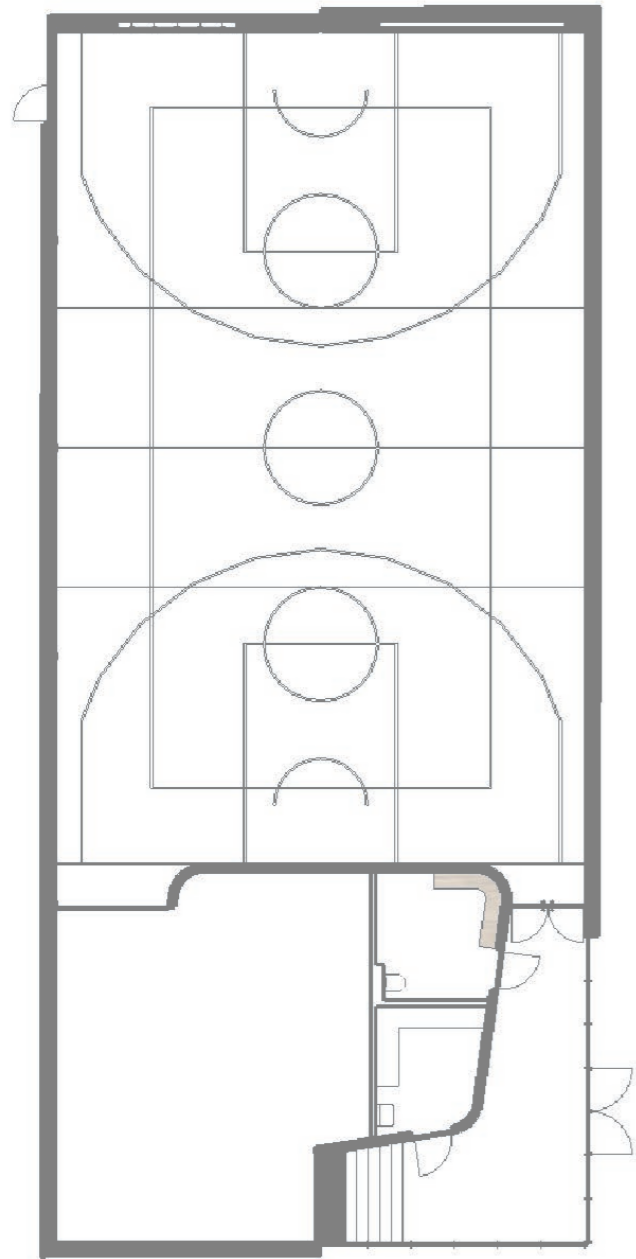

# EERSTE VERDIEPING (lokalen)

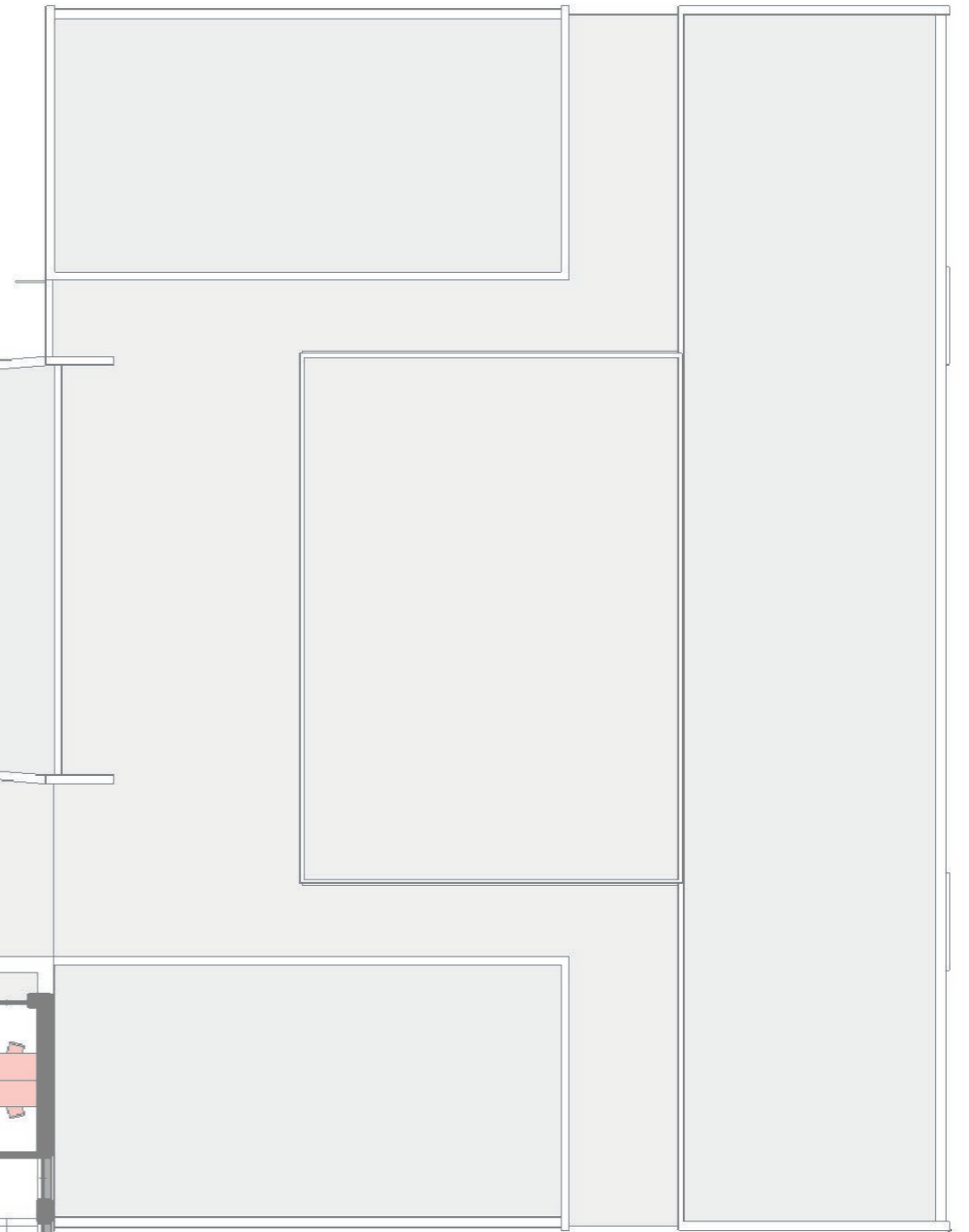
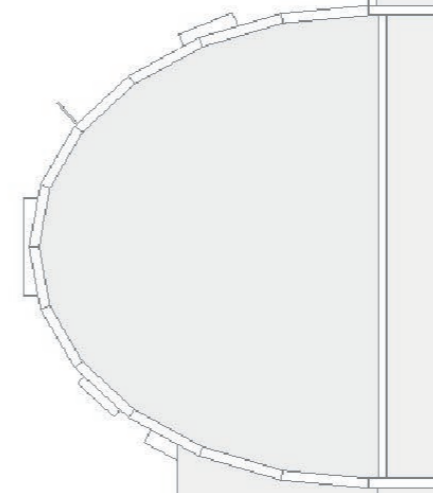
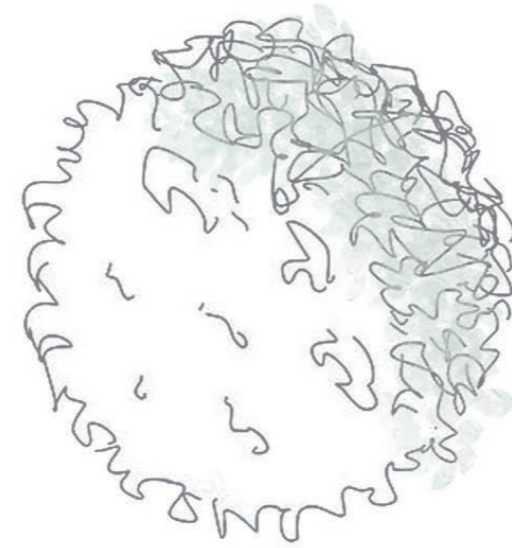
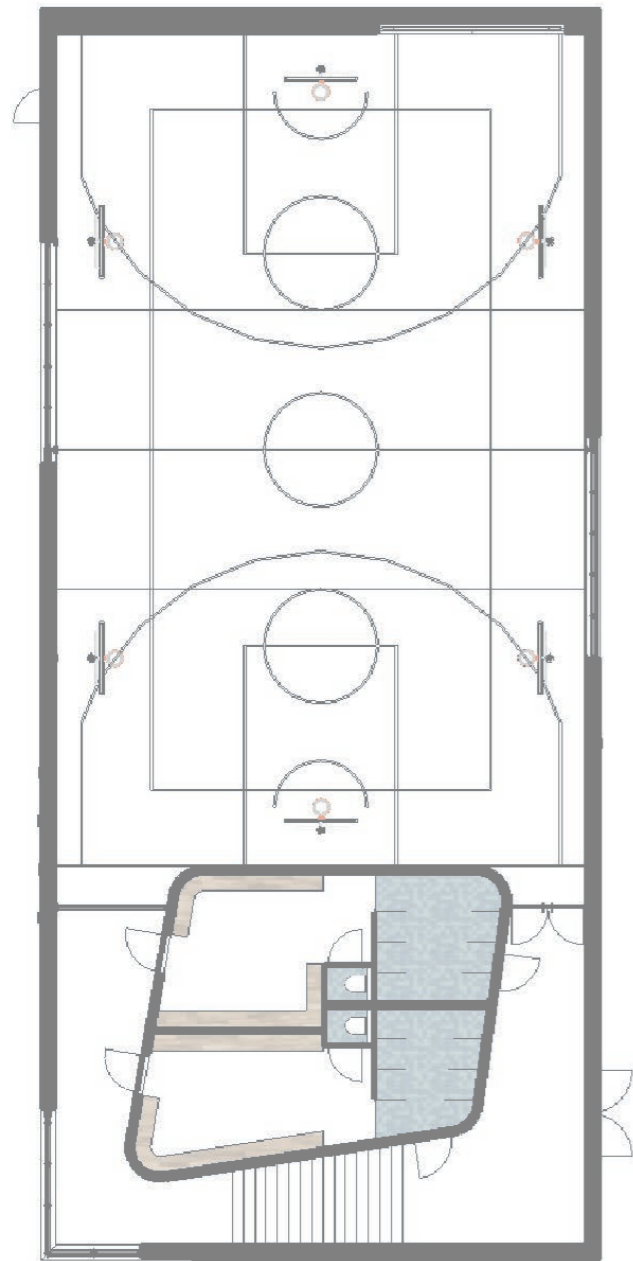











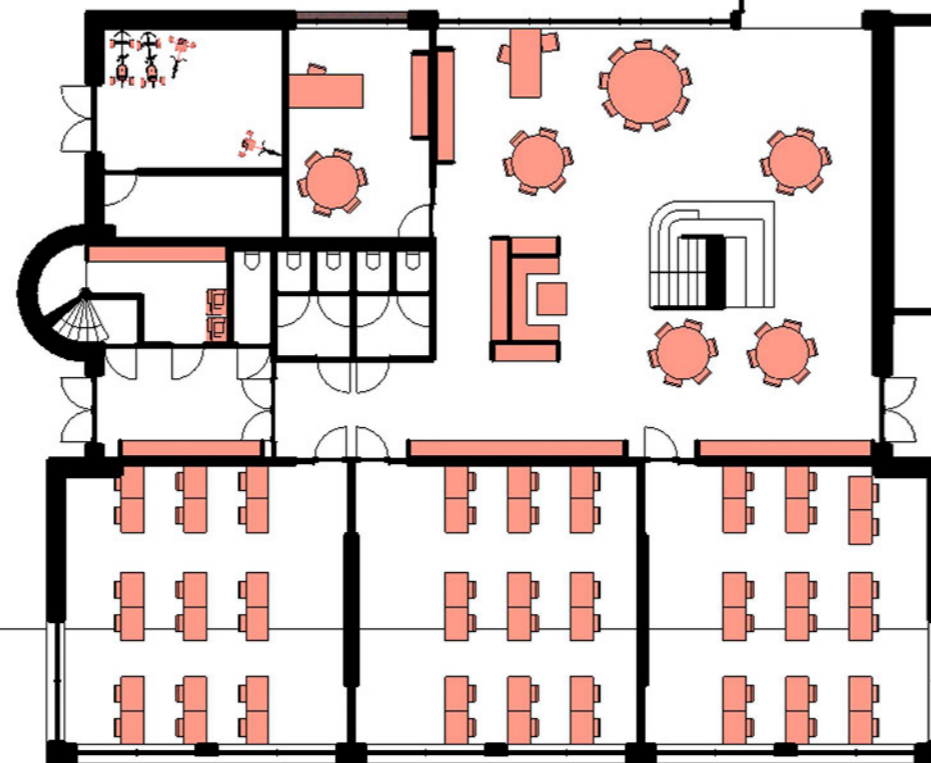
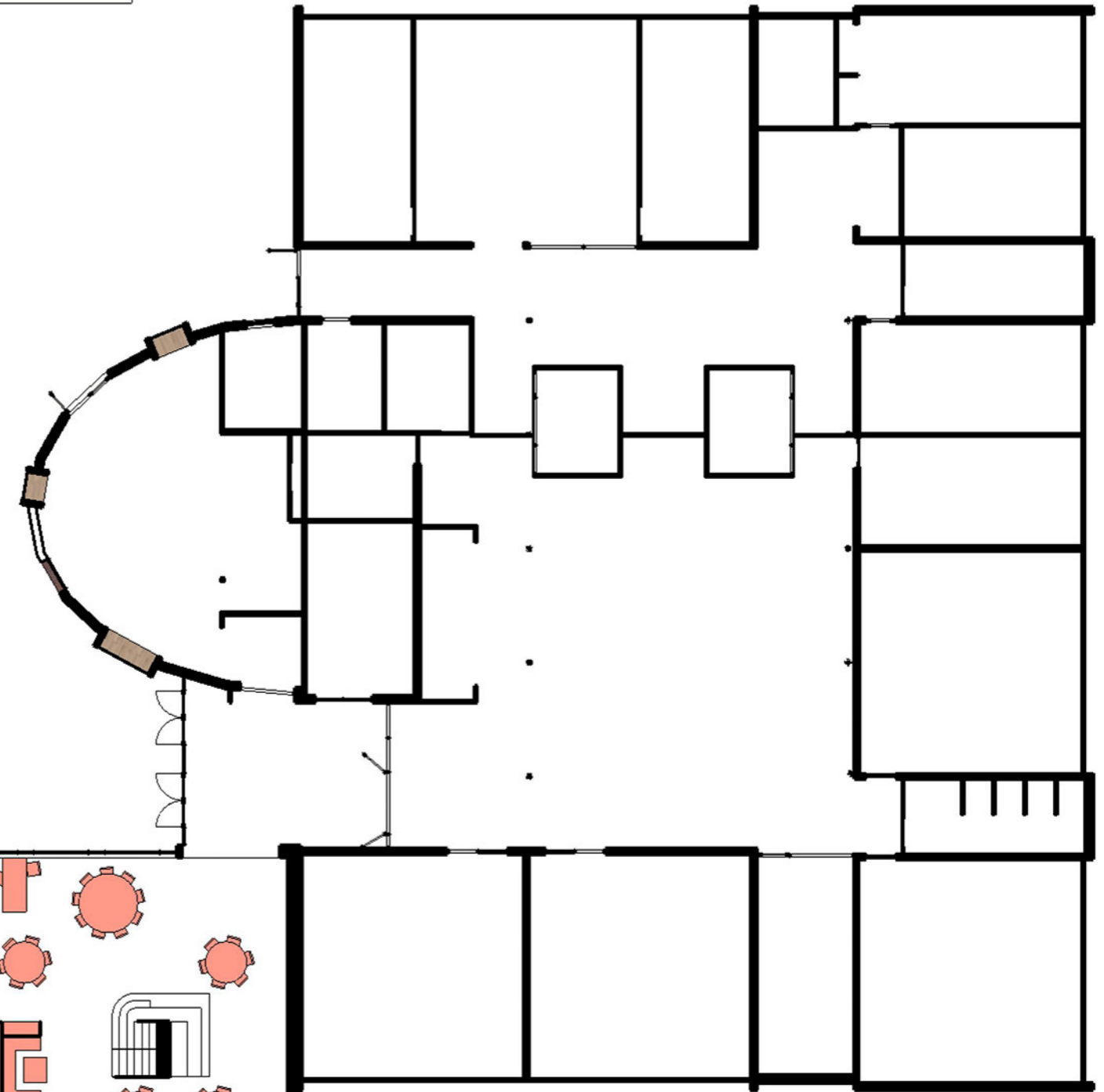
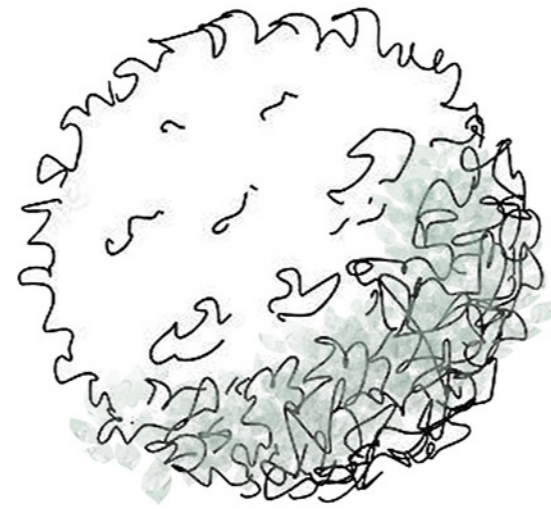
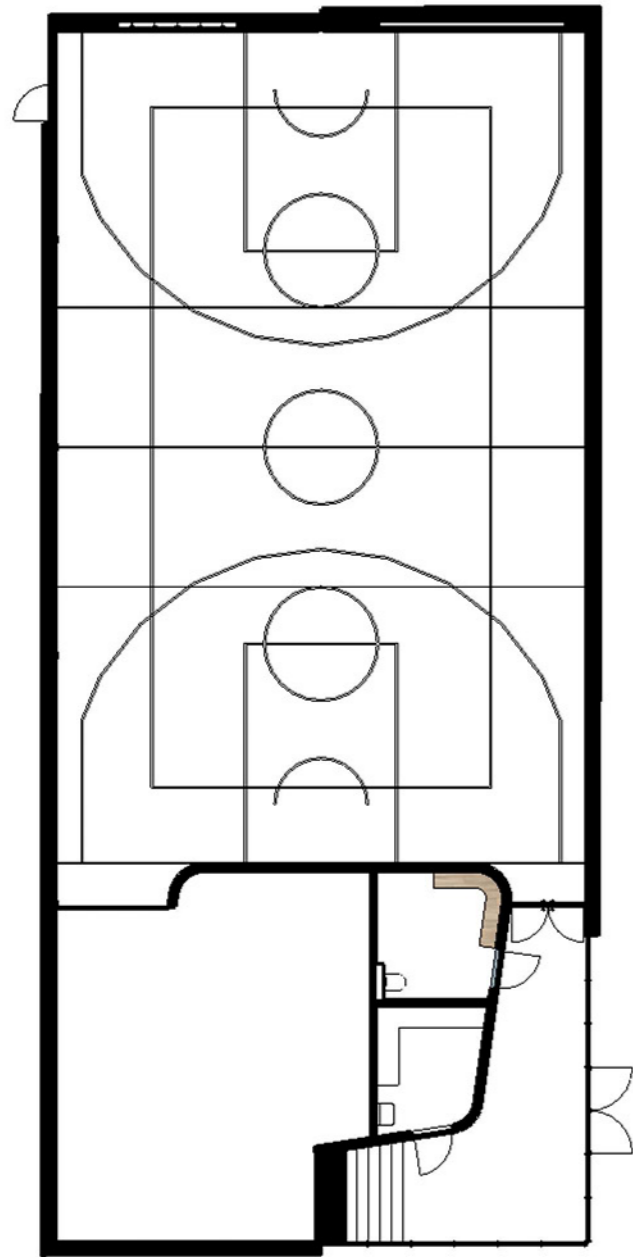

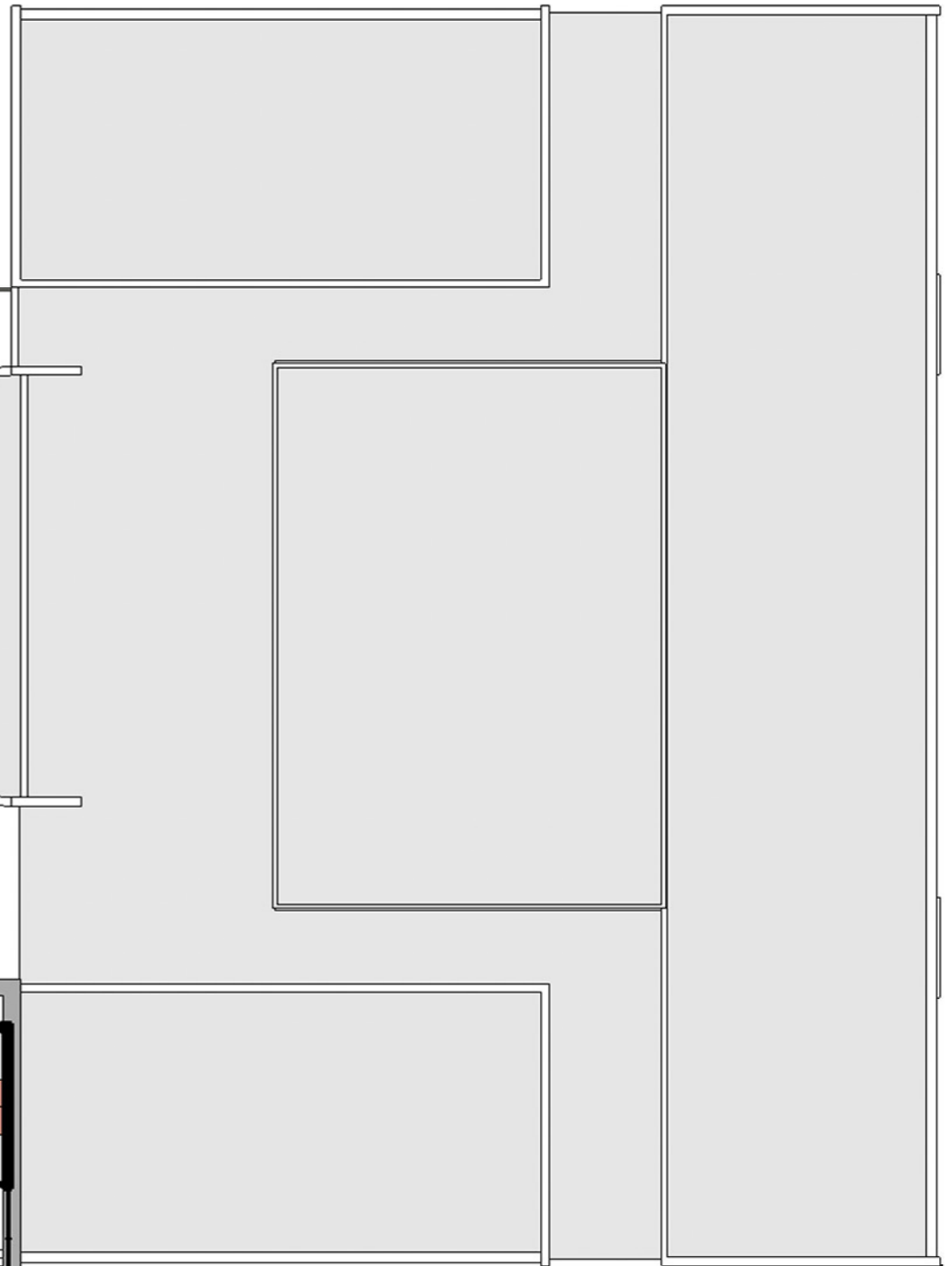
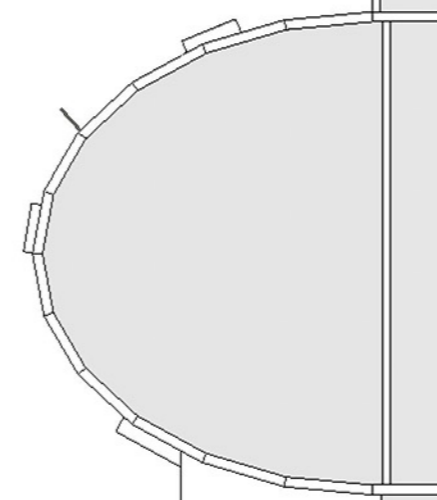
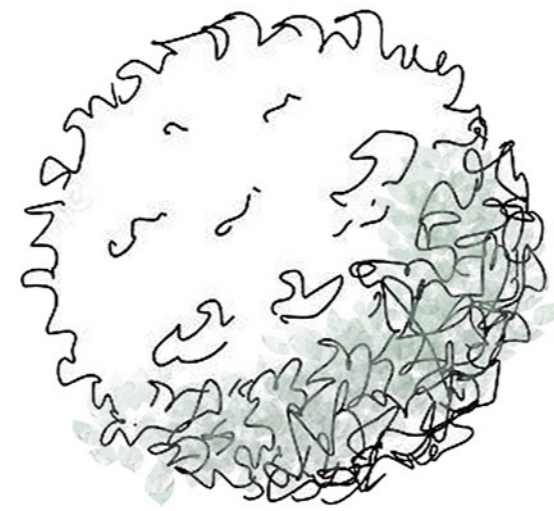
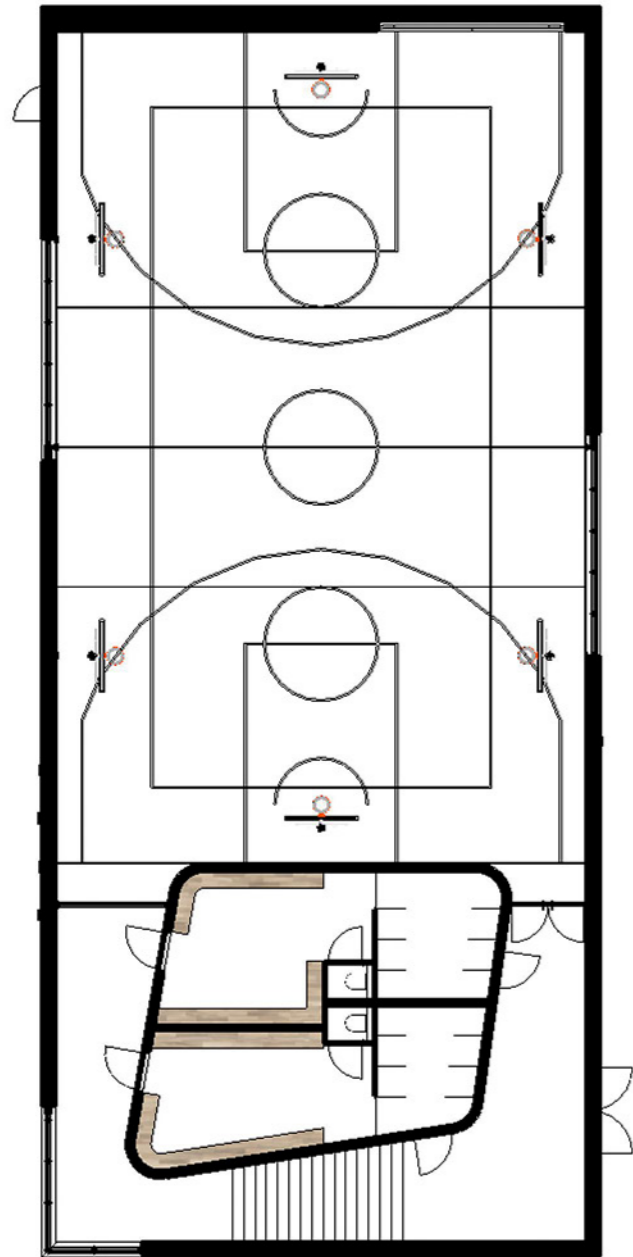







Mollerusweg 82  
2031 BZ Haarlem  
t +31 (0)23 369 000 3

[info@boparchitecten.nl](mailto:info@boparchitecten.nl)  
[www.boparchitecten.nl](http://www.boparchitecten.nl)